

MIAMI

Dit hoogglans witte acryl bad heeft een ligzijde en een afgerond voeteneind. De rugvorm is in twee richtingen afgerond, waardoor een comfortabele ligvorm is ontstaan. Het bad is symmetrisch, dus in een rechter en een linker hoek te plaatsen.



Riho acryl baden zijn gemaakt van hoogwaardig acryl, versterkt en door en door wit van kleur. De acryl baden zijn UV-bestendig. Het materiaal is volledig poriënvrij. Kalk hecht slecht waardoor er geen bacteriën achterblijven. Daarom zijn de baden gemakkelijk schoon te maken. Het oppervlak is aangenaam warm. Standaard bevat het bad geen potenset en overloop/afvoer.

Artikelnr.	L x W x H (cm)	Volume* (ltr)	Gewicht (kg)	Water hoogte (cm)	Optie Rihopool**
B058001005	150 x 70 x 43	80	15	35	Air / Flow
B059001005	160 x 70 x 43	90	18	35	Air / Flow
B060001005	170 x 70 x 43	105	20	35	Air / Flow
B061001005	180 x 80 x 43	140	23	35	Air / Flow

* Het volume van het bad is inclusief het gemiddelde volume van één persoon.

** Bij Rihopool whirlpoolsystemen is de pootset inbegrepen.

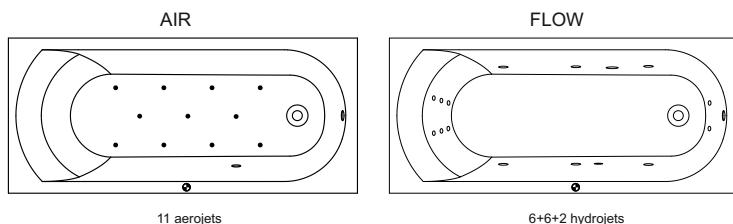

Additioneel aan te schaffen

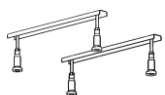

Pootset 01U
207093

Bij whirlpools is de pootset inbegrepen!



Mc Alpine
208867



Riho zwart
208711



Viega Multiplex
208873



Viega Multitplex Trio
208875

Optioneel aan te schaffen



Hoofdsteen 19
207043



Hoofdsteen 19
207044



Hoofdsteen 13
207035



Hoofdsteen 13
207036

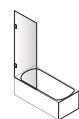

Zie volgende
pagina

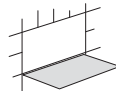

Inspectie luik
207019

Data onder voorbehoud van wijzigingen

DOUCHESCHERM

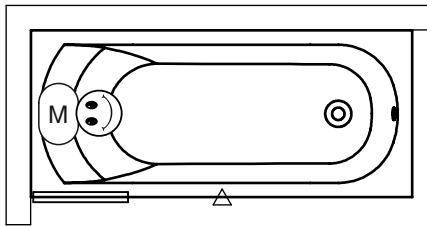

Scandic X107	Scandic X108	Scandic X109	Scandic X109V	Scandic X409	Scandic X500	Novik Z107	Novik Z500	Grid GB501	Lucid GD501
--------------	--------------	--------------	---------------	--------------	--------------	------------	------------	------------	-------------

Rechter type

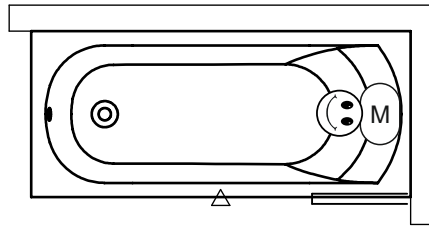

Linker type



-  Motor Hydro of Aero
-  Bediening
-  Service luik

BAD	Voor paneel	Zij paneel	Hoogte (cm)
B058001005	209296	209279	57
B059001005	209298	209279	57
B06001005	209301	209279	57
B061001005	209307	209281	57

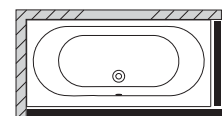
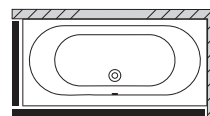
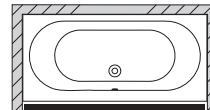

	A	B	C	D	E	F	G
B058001005	150	70	43	132	100	41,5	58
B059001005	160	70	43	142,5	110	41,5	58
B060001005	170	70	43	152,5	120	41,5	58
B061001005	180	80	43	162,5	130	41,5	68

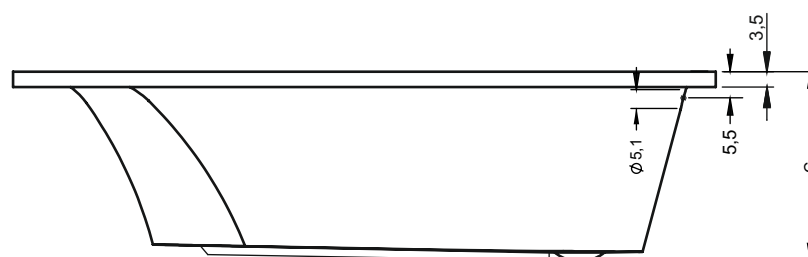
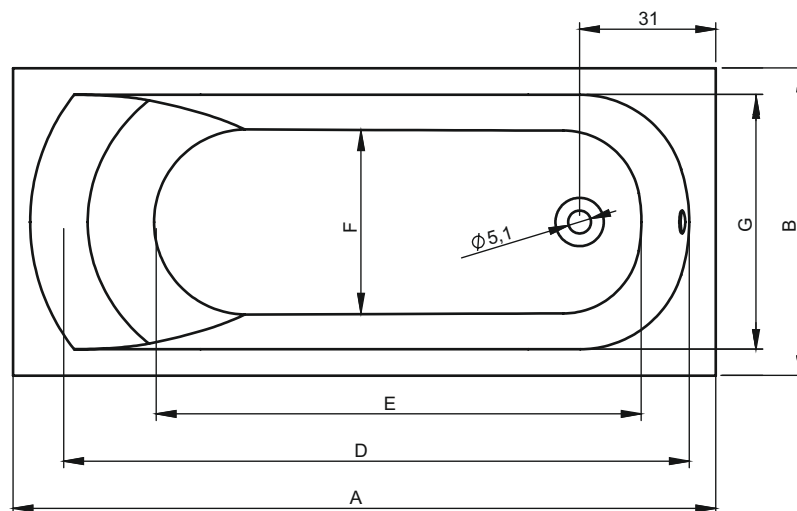

Data onder voorbehoud van wijzigingen