

SAVONA

This high-gloss white acrylic bath has a modern loft-like design and is ideal for two people side by side. It is also the largest bath in the range of Riho acrylic baths. The overflow is thus under the large black - integrated in the design headrest placed, that the water height is maximum. In the bottom there is a pop-up. The foot end is quite vertical, which creates a spacious bottom size.



Riho acrylic baths are made of high-quality cast acrylic, fully reinforced and all through white in colour. Our acrylic baths are non-aging and UV resistant. The material is completely pore-free and smooth. Lime will adhere poorly so no bacteria remain, also it makes the baths easy to clean. Its surface is pleasantly warm. Standard the bath doesn't include a legset and overflow/drain.

Article nr.	L x W x H (cm)	Volume* (ltr)	Weight (kg)	Water height (cm)	Option Rihopool**
B065001005	190 x 130 x 48	370	38	40	Air / Flow / Joy / Bliss

* The contents of the baths are measured including the (average) volume of two persons.

** Rihopool whirlpool systems already include a legset.

AIR

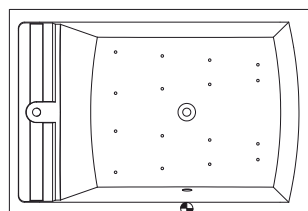

16 aer jets

FLOW

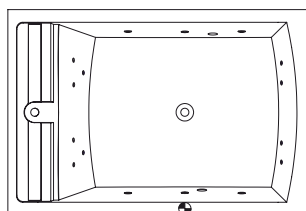

6+6+4 hydro jets

JOY

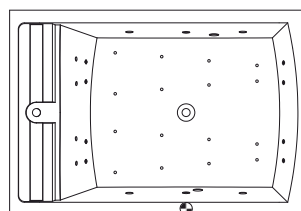

16 aer jets | 6+8+4 hydro jets

BLISS

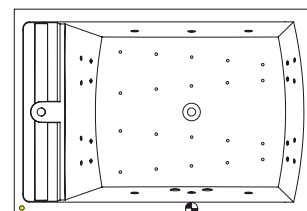

20 aer jets | 6+8+8 hydro jets

Included



Savona/Anna Headrest

Additional to purchase

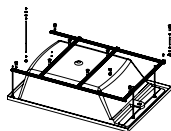

Legset 16
207100

Whirlpools already include a legset!



Clic-clac drain/siphon
208872

Optional to purchase



See next page

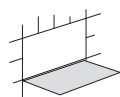

Inspection hatch
207019





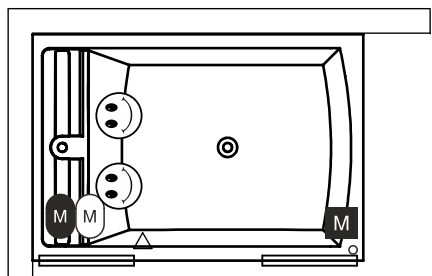

Data is subject to changes and/or errors

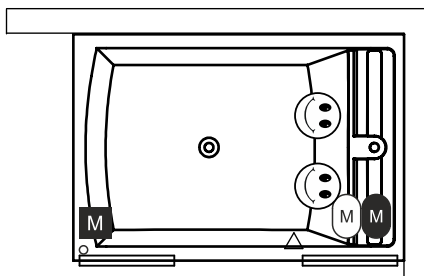
Right type



Left type



-  Motor in Air or Flow (Hydro or Aero)
Hydro motor in Joy and Bliss (Hydro + Aero)
-  Aero Motor in Joy and Bliss (Hydro + Aero)
-  2nd Hydromotor in Bliss
-  Control panel
-  Cleanpool inlet
-  Service hatch

Bath screen

Scandic X107	Scandic X108	Scandic X109	Scandic X109V	Scandic X409	Scandic X500	Novik Z107	Novik Z500	Grid GB501	Lucid GD501
--------------	--------------	--------------	---------------	--------------	--------------	------------	------------	------------	-------------

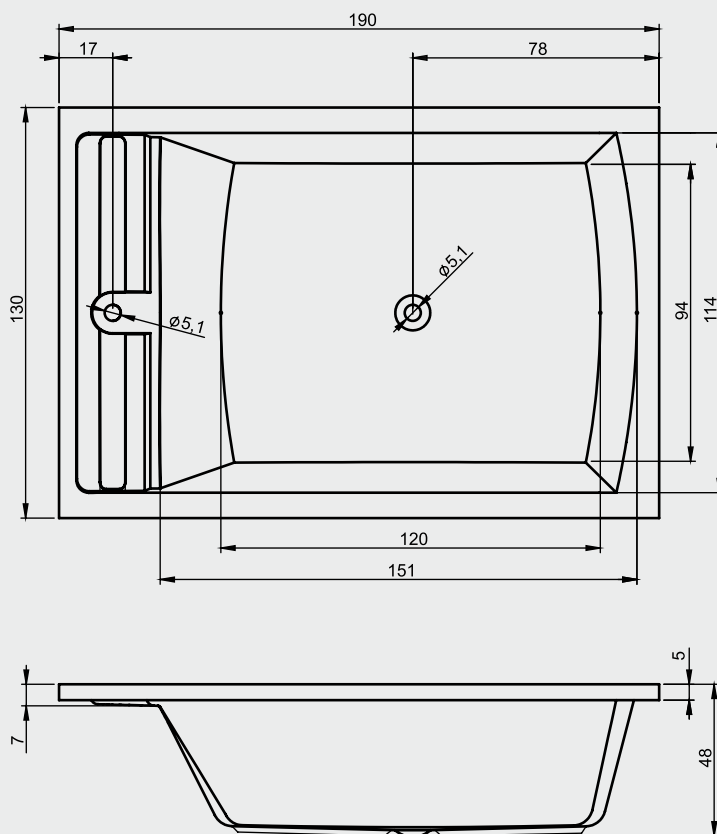

Data is subject to changes and/or errors